

Engineering Specification

Job Name _____

Contractor _____

Job Location _____

Approval _____

Engineer _____

Contractor's P.O. No. _____

Approval _____

Representative _____

Series 909RPDA

Reduced Pressure Detector Assemblies

Sizes: 2½" – 10"

Series 909RPDA Reduced Pressure Detector Assemblies are used in health hazard applications and are designed exclusively for use in accordance with water utility authority containment requirements. It is mandatory to prevent the reverse flow of fire protection system substances, i.e., glycerin wetting agents, stagnant water and water of non-potable quality from being pumped or siphoned into the potable water line.

Benefits: Detects leaks . . . with emphasis on the cost of unaccountable water; incorporates a meter which allow the water utility to:

- detect leaks that historically create great annual cost due to waste
 - provide a detection point for unauthorized use. It can help locate illegal taps
- Modular check design concept facilitates maintenance and assembly access. The coating on this backflow assembly uses ArmorTek™ technology to resist corrosion due to microbial induced corrosion (MIC) or exposed metal substrate. All sizes are standardly equipped with AWWA epoxy coated, UL/FM listed OSY resilient seated gate valves, CFM (cubic feet per minute) or GPM (gallon per minute) meter and ball type test cocks. A pressure differential relief valve is located in a zone between the check valves.

Modular Design

Features a modular design concept which facilitates maintenance and assembly access. All sizes are standardly equipped with gate valves and ball type test cocks.

Features

- Body construction fused epoxy coated cast iron
- Replaceable bronze seats
- Maximum flow at low pressure drop
- Compact for economy combined with performance
- Design simplicity for easy maintenance
- Utilizes advanced ArmorTek™ coating technology to resist corrosion of internals
- Furnished with 5/8" x 3/4" (16 x 19mm) meter
- Air-in/Water-out relief valve design provides maximum capacity during emergency conditions.
- No special tools required

Specifications

A Reduced Pressure Detector Assembly shall be installed on fire protection systems when connected to a public water supply. Degree of hazard present is determined by the local authority having jurisdiction. The unit shall be a complete assembly including UL listed and FM approved OSY shutoff valves. Including an auxiliary line consisting of an approved backflow preventer and water meter. The valve body shall utilize a coating system with built in electrochemical corrosion inhibitor and microbial inhibitor. The assembly shall meet the requirements of AWWA C511-92; ASSE 1047; UL Classified File No. EX3185; CSA B64 and USC Manual 8th. Edition. Assembly shall be a Watts Series 909RPDA.

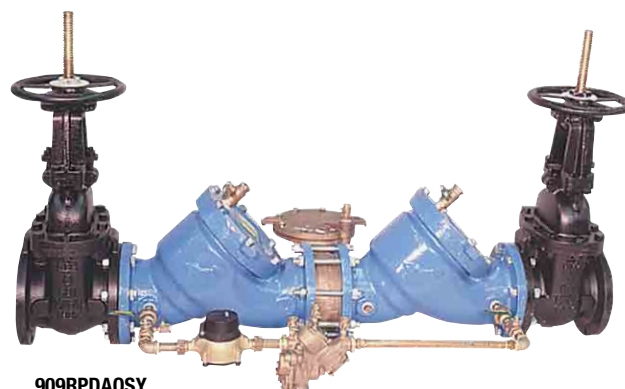

909RPDA0SY

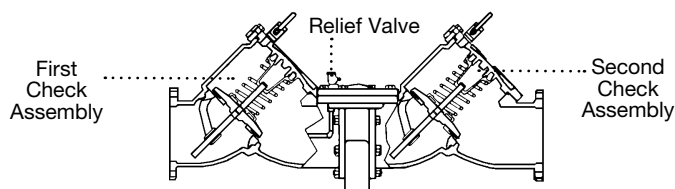

How it operates

The unique relief valve construction incorporates two channels: one for air, one for water. When the relief valve opens, as in the accompanying air-in/water-out diagram, the right-hand channel admits air to the top of the reduced pressure zone, relieving the zone vacuum. The channel on the left then drains the zone to atmosphere. Therefore, if both check valves foul, and simultaneous negative supply and positive backpressure develops, the relief valve uses the air-in/water-out principle to stop potential backflow.

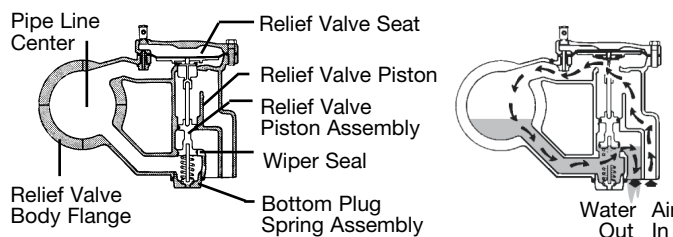

Now Available
WattsBox Insulated Enclosures.

For more information, send for literature ES-WB.

NOTICE

The information contained herein is not intended to replace the full product installation and safety information available or the experience of a trained product installer. You are required to thoroughly read all installation instructions and product safety information before beginning the installation of this product.

NOTICE

Inquire with governing authorities for local installation requirements

Watts product specifications in U.S. customary units and metric are approximate and are provided for reference only. For precise measurements, please contact Watts Technical Service. Watts reserves the right to change or modify product design, construction, specifications, or materials without prior notice and without incurring any obligation to make such changes and modifications on Watts products previously or subsequently sold.



Models

Suffix:

- OSY – UL/FM outside stem and yoke resilient seated gate valves
- CFM – cubic feet per minute meter
- GPM – gallons per minute meter
- LF – less shutoff valves

Materials

- Discs: Rubber
- Body: Epoxy coated cast iron
- Seat and Disc Holder: Bronze
- Trim: Stainless steel
- Test Cocks: Bronze

Pressure – Temperature

- Temperature Range: 33°F – 140°F (0.5°C – 60°C) continuous
- Maximum Working Pressure: 175psi (12.1 bar)

Dimensions – Weights

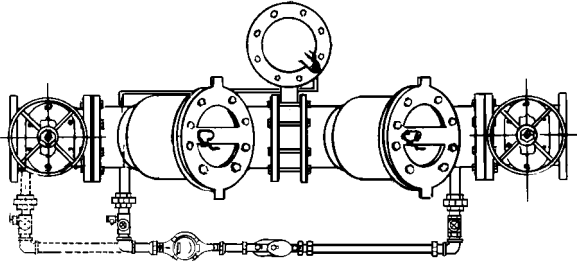

NOTE: Piping for 3" 909 will start from #1 gate valve and connect at #2 check valve.

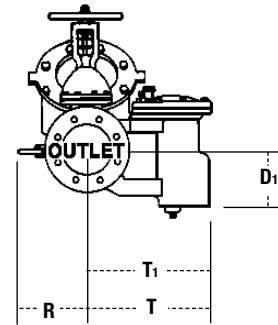
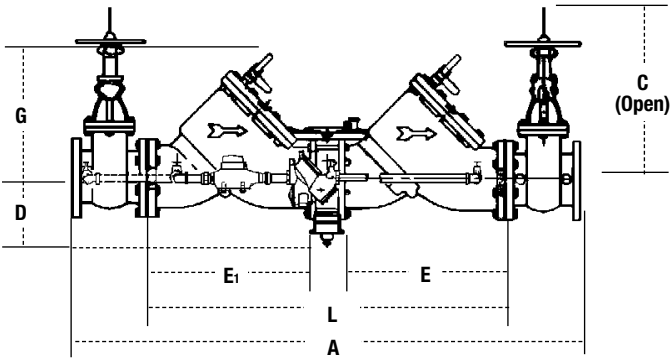

SIZE	DIMENSIONS												WEIGHT									
	A		C		D		D1		E, E1		G		L		R		T		T1			
in.	in.	mm	in.	mm	in.	mm	in.	mm	in.	mm	in.	mm	in.	mm	in.	mm	in.	mm	in.	mm	lbs.	kgs.
2½	41¼	1070	16⅞	416	5¼	133	4¼	114	12	305	7	178	26⅞	664	14	356	9	229	7⅞	194	230	104
3	42¼	1070	18⅞	479	5¼	133	4¼	114	12	305	7	178	26⅞	664	14	356	9	229	7⅞	194	230	104
4	55⅞	1400	22¾	578	6	152	5⅞	149	17	432	9½	241	37	940	15	381	13⅞	346	11¼	299	470	213
6	65½	1664	30⅞	765	6	152	6	152	20¾	527	14½	368	45	1130	16	406	13⅞	346	11¼	299	798	362
8	78½	1994	37¾	959	9¾	248	8⅞	219	26	660	18½	470	55¼	1403	17	432	18½	470	16⅞	416	1456	660
10	93⅞	2378	45¾	1162	9¾	248	8⅞	219	32	813	21½	546	67½	1715	18	457	18½	470	16⅞	416	2230	1012

Standards

- AWWA C511-92; CSA B64
- USC Manual for Cross-connection Control, 8th Edition

Approvals



Approved by the foundation for Cross-Connection Control and Hydraulic Research at the University of Southern California.

Series 909AG AIR GAPS

When installing a drain line, use Series 909 air gaps on Model 909 backflow preventers.

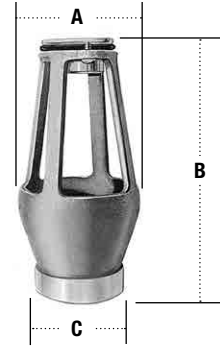

Iron Body Model	Ordering Code	Series/Sizes	Dimensions			Weight				
			A	B	C	lbs	kgs			
			in.	mm	in.	mm	in.	mm		
909AG-F	0881378	1¼" – 3" 009/909								
		1¼" – 2" 009 M1	4⅜"	111	6¾	171	2	51	3.25	1.47
		2" 009 M2								
909AG-K	0881385	4" – 6" 909 8" – 10" 909 M1	6⅞"	162	9⅞	244	3	76	6.25	2.83
909AG-M	0881387	8" – 10" 909	7⅞"	187	11¼	286	4	102	15.50	7.03

Capacity

*Typical maximum flow rate (7.5 feet/sec.) **UL rated flow

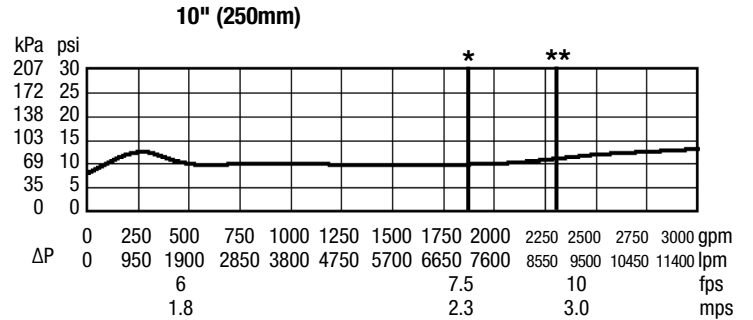
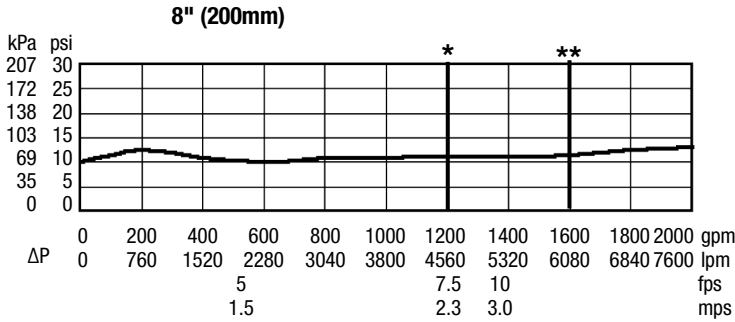
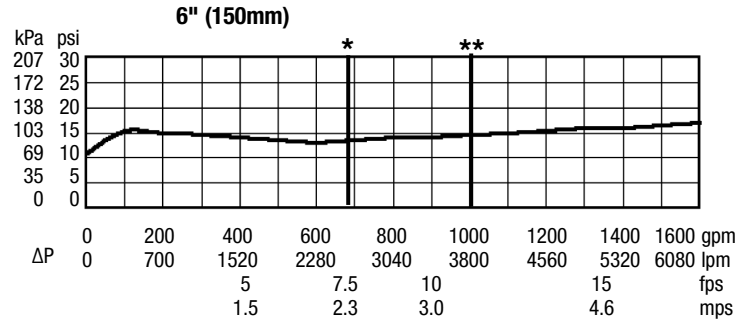
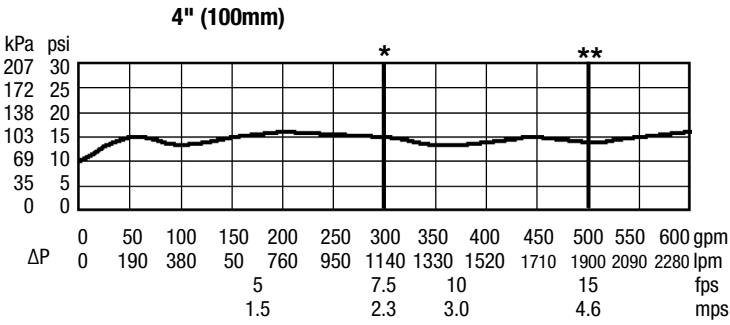
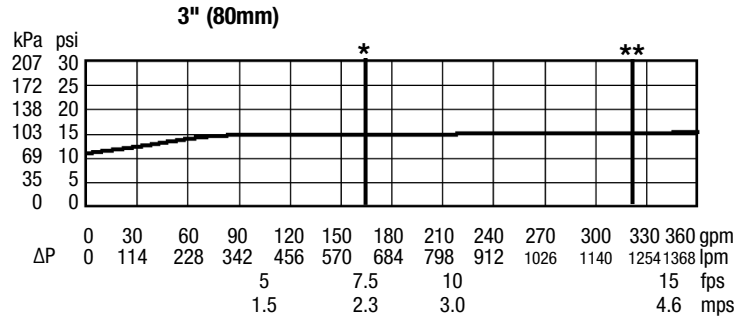
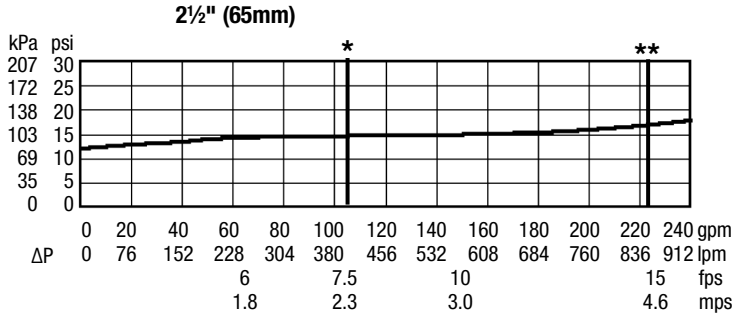



USA: T: (978) 689-6066 • F: (978) 975-8350 • Watts.com
Canada: T: (888) 208-8927 • F: (905) 481-2316 • Watts.ca
Latin America: T: (52) 55-4122-0138 • Watts.com